

17 inch Wide Screen TFT LCD Monitor



HG171
USER'S MANUAL

Before operating the monitor, please read this manual thoroughly. This manual should be retained for future reference.

FCC Class B Radio Frequency Interference Statement

This equipment has been tested and found to comply with the limits for a Class B digital device, pursuant to Part 15 of the FCC Rules. These limits are designed to provide reasonable protection against harmful interference in a residential installation. This equipment generates, uses and can radiate radio frequency energy, and if not installed and used in accordance with the instructions, may cause harmful interference to radio communications. However, there is no guarantee that interference will not occur in a particular installation. If this equipment does cause harmful interference to radio or television reception, which can be determined by turning the equipment off and on, the user is encouraged to try to correct the interference by one or more of the following measures:

- Reorient or relocate the receiving antenna.
- Increase the separation between the equipment and receiver.
- Connect the equipment into an outlet on a circuit different from that to which the receiver is connected.
- Consult the dealer or an experienced radio/TV technician for help.

The device complies with Parts 15 of the FCC Rule. Operation is subject to the following two conditions : (1) this device may not cause harmful interference ; and (2) this device must accept any interference received, including interference that may cause undesired operations.

CANADA

This Class B digital apparatus meets all requirements of the Canadian Interference-Causing Equipment Regulation.



This device complies with requirement of EMC directive 89/336/EEC with regard to Electromagnetic Compatibility, and 73/23/EEC and 93/68/EEC with regard to Low Voltage directive.

Socket-outlet shall be near the equipment and shall be accessible.



Congratulations!

The display you have just purchased carries the TCO'03 Displays label. This means that your display is designed, manufactured and tested according to some of the strictest quality and environmental requirements in the world. This makes for a high performance product, designed with the user in focus that also minimizes the impact on our natural environment.

Some of the features of the TCO'03 Display requirements:

Ergonomics

- Good visual ergonomics and image quality in order to improve the working environment for the user and to reduce sight and strain problems. Important parameters are luminance, contrast, resolution, reflectance, colour rendition and image stability.

Energy

- Energy-saving mode after a certain time – beneficial both for the user and the environment
- Electrical safety

Emissions

- Electromagnetic fields
- Noise emissions

Ecology

- The product must be prepared for recycling and the manufacturer must have a certified environmental management system such as EMAS or ISO 14 001
- Restrictions on
 - chlorinated and brominated flame retardants and polymers
 - heavy metals such as cadmium, mercury and lead.

The requirements included in this label have been developed by TCO Development in cooperation with scientists, experts, users as well as manufacturers all over the world. Since the end of the 1980s TCO has been involved in influencing the development of IT equipment in a more user-friendly direction. Our labelling system started with displays in 1992 and is now requested by users and IT-manufacturers all over the world.

For more information, please visit
www.tcodevelopment.com

Recycling Information

We, the **Hanns.G** care very much about our environment protection strategy and firmly believe that it helps us have healthier earth via appropriate treatment and recycling of industrial technology devices at the end-of-life.

These devices contain recyclable materials, which can be re-decomposed and re-integrated into brand-new marvels. On the contrary, other material can be classified to hazardous and poisoned substances. We strongly encourage you to contact the provided information to recycle this product.

For more information, please visit
www.hannsg.com

TABLE OF CONTENTS

SAFETY NOTICE	6
PRECAUTIONS	6
SPECIAL NOTES ON LCD MONITORS	7
BEFORE YOU OPERATE THE MONITOR	8
FEATURES	8
CHECKING THE CONTENTS OF THE PACKAGE	8
INSTALLATION INSTRUCTIONS	9
POWER.....	9
MAKING CONNECTIONS.....	10
ADJUSTING THE VIEWING ANGLE	11
OPERATING INSTRUCTIONS.....	12
GENERAL INSTRUCTIONS.....	12
FRONT PANEL CONTROL	13
HOW TO ADJUST A SETTING	14
PLUG AND PLAY	17
TECHNICAL SUPPORT (FAQ).....	18
Q & A FOR GENERAL PROBLEMS	18
ERROR MESSAGE & POSSIBLE SOLUTIONS	19
APPENDIX	20
SPECIFICATIONS	20

SAFETY NOTICE

1. The changes or modifications not expressly approved by the party responsible for compliance could void the user's authority to operate the equipment.
2. Shielded interface cables and AC power cord, if any, must be used in order to comply with the emission limits.
3. The manufacturer is not responsible for any radio or TV interference caused by unauthorized modification to this equipment. It is the responsibilities of the user to correct such interference.

WARNING:

To prevent fire or shock hazard, do not expose the monitor to rain or moisture. Dangerously high voltages are present inside the monitor. Do not open the cabinet. Refer servicing to qualified personnel only.

PRECAUTIONS

- Do not use the monitor near water, e.g. near a bathtub, washbowl, kitchen sink, laundry tub, swimming pool or in a wet basement.
- Do not place the monitor on an unstable cart, stand, or table. If the monitor falls, it can injure a person and cause serious damage to the appliance. Use only a cart or stand recommended by the manufacturer or sold with the monitor. If you mount the monitor on a wall or shelf, use a mounting kit approved by the manufacturer and follow the kit instructions.
- Slots and openings in the back and bottom of the cabinet are provided for ventilation. To ensure reliable operation of the monitor and to protect it from overheating, be sure these openings are not blocked or covered. Do not place the monitor on a bed, sofa, rug, or similar surface. Do not place the monitor near or over a radiator or heat register. Do not place the monitor in a bookcase or cabinet unless proper ventilation is provided.
- The monitor should be operated only from the type of power source indicated on the label. If you are not sure of the type of power supplied to your home, consult your dealer or local power company.
- Unplug the unit during a lighting storm or when it will not be used for long period of time. This will protect the monitor from damage due to power surges.
- Do not overload power strips and extension cords. Overloading can result in fire or electric shock.
- Never push any object into the slot on the monitor cabinet. It could short circuit parts causing a fire or electric shock. Never spill liquids on the monitor.
- Do not attempt to service the monitor by yourself; opening or removing covers can expose you to dangerous voltages and other hazards. Please refer all servicing to qualified service personnel.
- To ensure satisfactory operation, use the monitor only with UL listed computers which have appropriate configured receptacles marked between 100 - 240V AC, Min. 5A.
- The wall socket shall be installed near the equipment and shall be easily accessible.

SPECIAL NOTES ON LCD MONITORS

The following symptoms are normal with LCD monitor and do not indicate a problem.

- Due to the nature of the fluorescent light, the screen may flicker during initial use. Turn off the Power Switch and then turn it on again to make sure the flicker disappears.
- You may find slightly uneven brightness on the screen depending on the desktop pattern you use.
- The LCD screen has effective pixels of 99.99% or more. It may include blemishes of 0.01% or less such as a missing pixel or a pixel lit all of the time.
- Due to the nature of the LCD screen, an afterimage of the previous screen may remain after switching the image, when the same image is displayed for hours. In this case, the screen is recovered slowly by changing the image or turning off the Power Switch for hours.
- If the screen suddenly flashes erratically or the backlighting fails, please contact your dealer or service center for repair. Do not attempt to repair the monitor yourself.

Lamp Disposal



LAMP(S) INSIDE THIS PRODUCT CONTAIN MERCURY AND MUST BE RECYCLED OR DISPOSED OF ACCORDING TO LOCAL, STATE OR FEDERAL LAWS. FOR MORE INFORMATION, CONTACT THE ELECTRONIC INDUSTRIES ALLIANCE AT WWW.EIAE.ORG. FOR LAMP SPECIFIC DISPOSAL INFORMATION CHECK WWW.LAMPRECYCLE.ORG.

BEFORE YOU OPERATE THE MONITOR

FEATURES

- 17" Wide screen TFT Color LCD Monitor
- Crisp, Clear Display for Windows
- Recommended Resolutions: 1440 X 900 @60Hz
- EPA ENERGY STAR®
- Ergonomic Design
- Space Saving, Compact Case Design

CHECKING THE CONTENTS OF THE PACKAGE

The product package should include the following items:

LCD Monitor

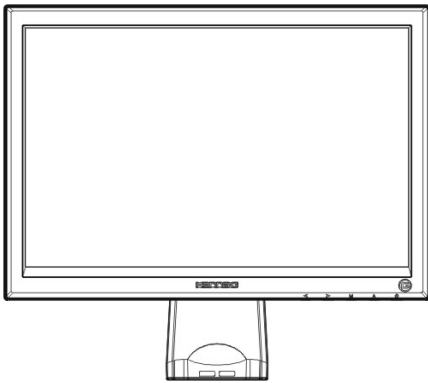

Screen

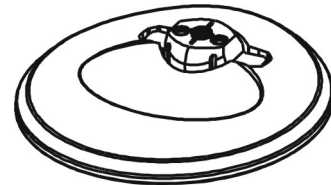

Base

Cables and User manual

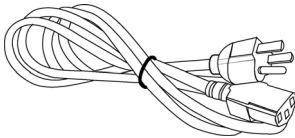

Power Cord

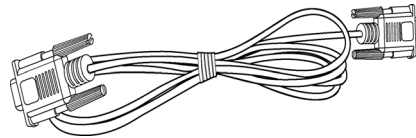

VGA Cable

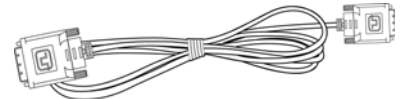

DVI-D Cable
(dual input mode optional)

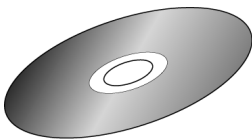

User's manual

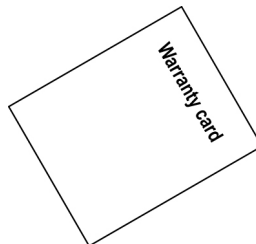

Warranty card



Audio Cable

INSTALLATION INSTRUCTIONS

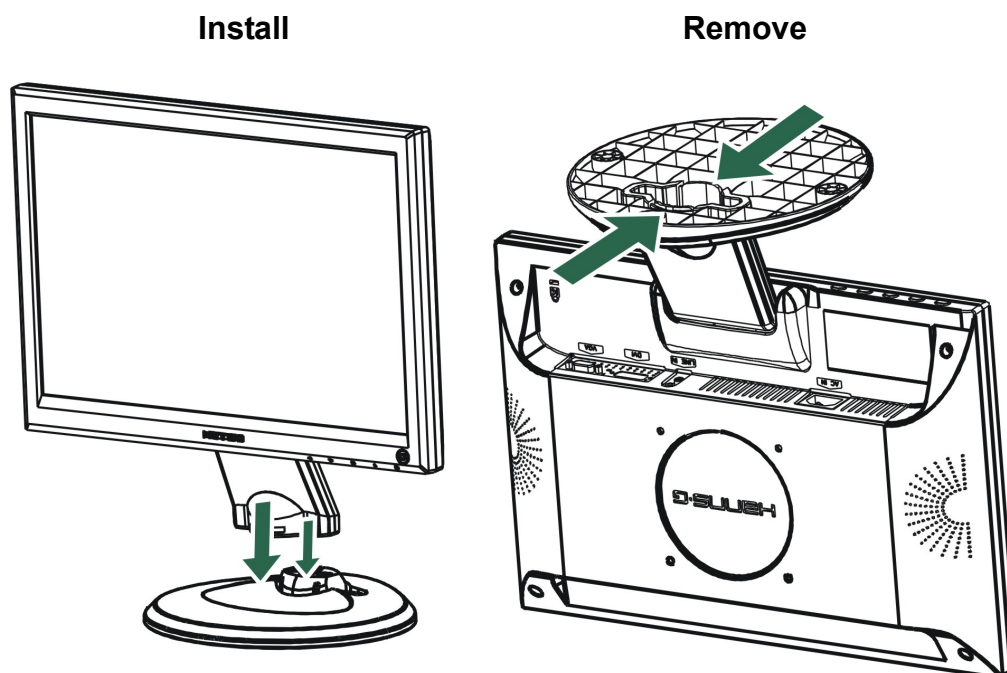

Figure.1. Installing and Removing the Base

INSTALLATION:

1. Align the monitor with the opening in the base.
2. Note that the longer section of the base points forward.
3. Snap the monitor into its base. A clear click sound will affirm that the base is connected correctly.
4. Verify that the monitor is securely attached to the base by looking at the bottom of the base and making sure that the clips are fully engaged in the base.

REMOVAL:

1. Flip over the monitor so that it is upside down.
2. Press the 2 clips on the base that holds the monitor in place.
3. Gently press and hold the 2 clips while pulling the base from the monitor unit they are unattached.

POWER

POWER SOURCE:

1. Make sure that the power cord is the correct type required in your area.
2. This LCD monitor has an Internal universal power supply that allows operation in either 100/120V AC or 220/240V AC voltage area (No user adjustment is required.)
3. Connect the AC-power cord one end to your LCD monitor's AC-input socket, the other end to wall-outlet .

MAKING CONNECTIONS

CONNECTING TO A PC

Turn off your computer before performing the procedure below.

1. Connect one end of the D-Sub cable to the back of the monitor and connect the other end to the computer's D-Sub port.
2. Connect one end of the DVI-D cable (**Dual input mode optional**) to the back of the monitor and connect the other end to the computer's DVI-D port.
3. Connect the audio cable between the monitor's audio input and the PC's audio output (green port).
4. Plug one end of the AC power cord to the LCD monitor's AC input socket, and the other end to Wall outlet.
5. Turn on your monitor and computer.

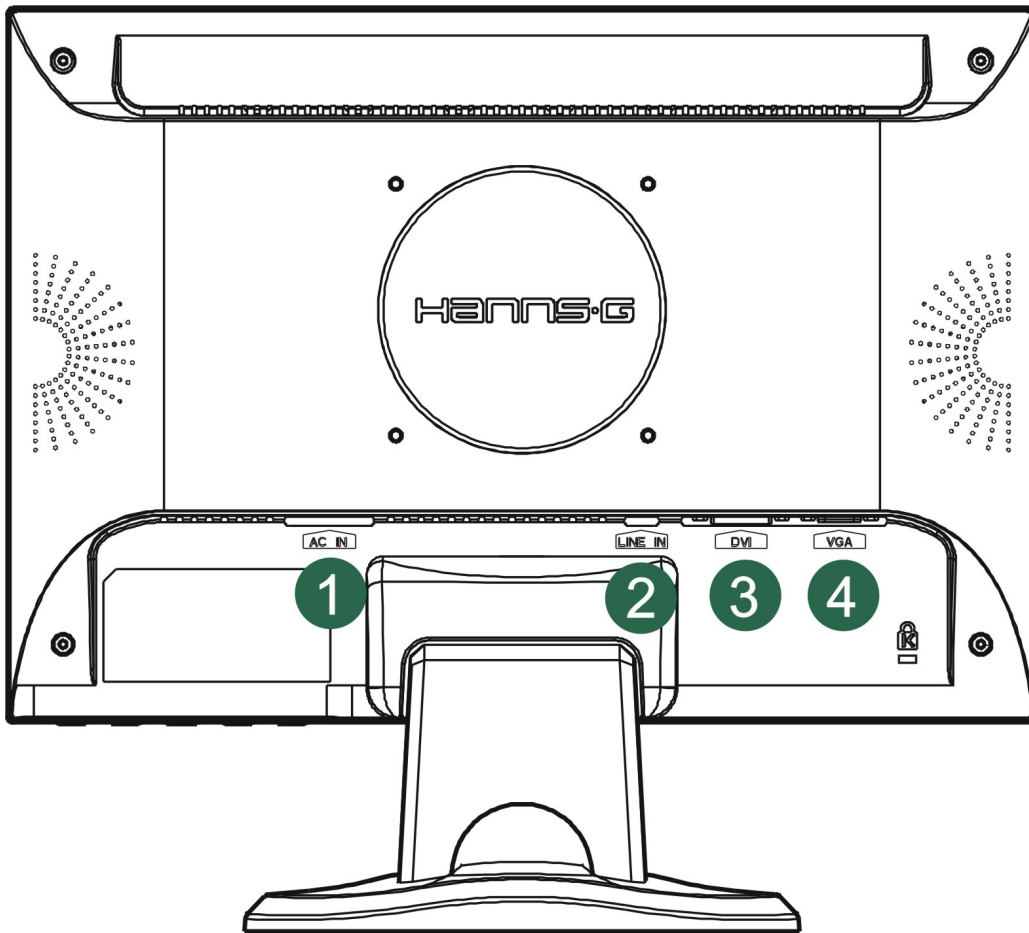

Figure.2. Connecting to a PC

1.	Power AC Input	2.	Audio Input
3.	DVI-D Input (optional)	4.	VGA Input

ADJUSTING THE VIEWING ANGLE

- For optimal viewing it is recommended to look at the full face of the monitor, then adjust the monitor's angle to your own preference.
- Hold the stand so you do not topple the monitor when you change the monitor's angle.
- You are able to adjust the monitor's angle from -5° to 20° .

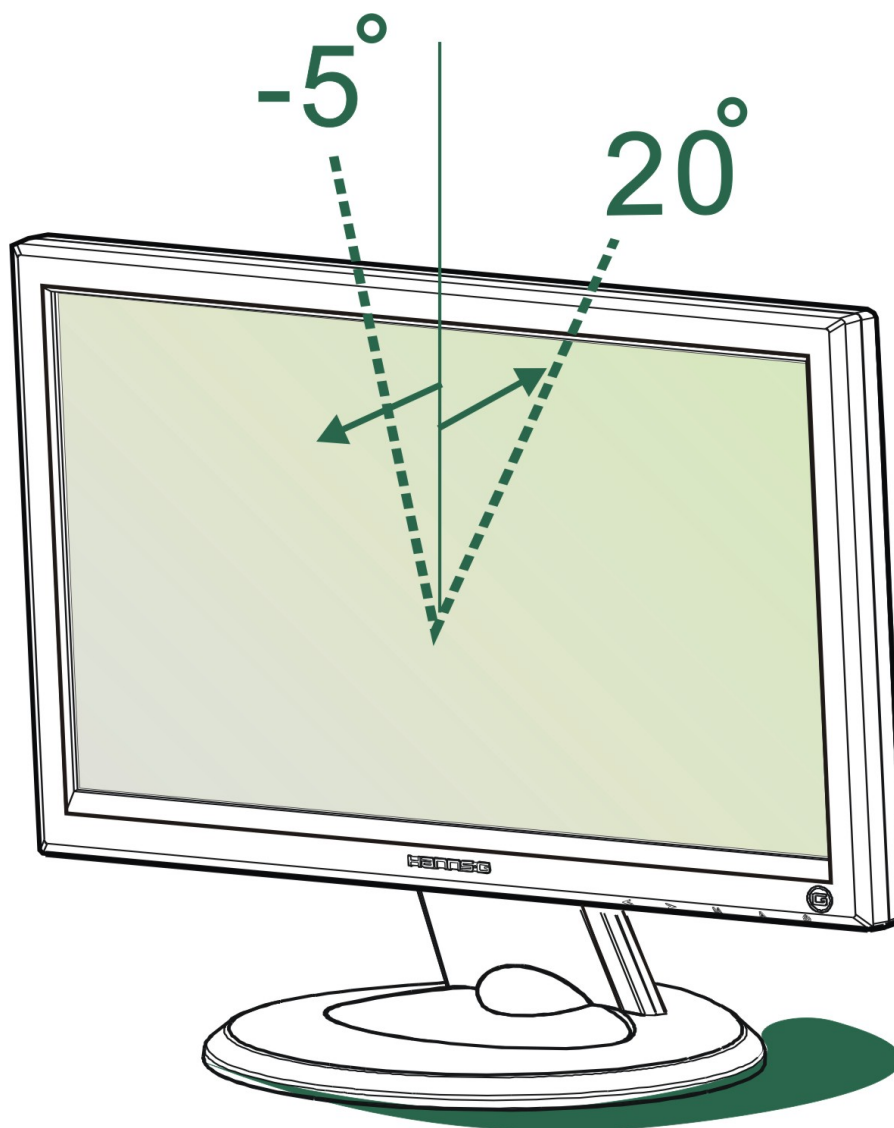

Figure.3. Monitor Angle

NOTES:

- Do not touch the LCD screen when you change the angle. It may cause damage or break the LCD screen.
- Be careful not to place fingers or hands near the hinges when tilting the monitor, otherwise pinching can result.

OPERATING INSTRUCTIONS

GENERAL INSTRUCTIONS

Press the power button to turn the monitor on or off. The other control buttons are located on the front panel of the monitor (See Figure 4). By changing these settings, the picture can be adjusted to your personal preferences.

- The power cord should be connected.
- Connect the Signal cable from the monitor to the VGA card.
- Press the power button to turn on the monitor. The power indicator will light up.

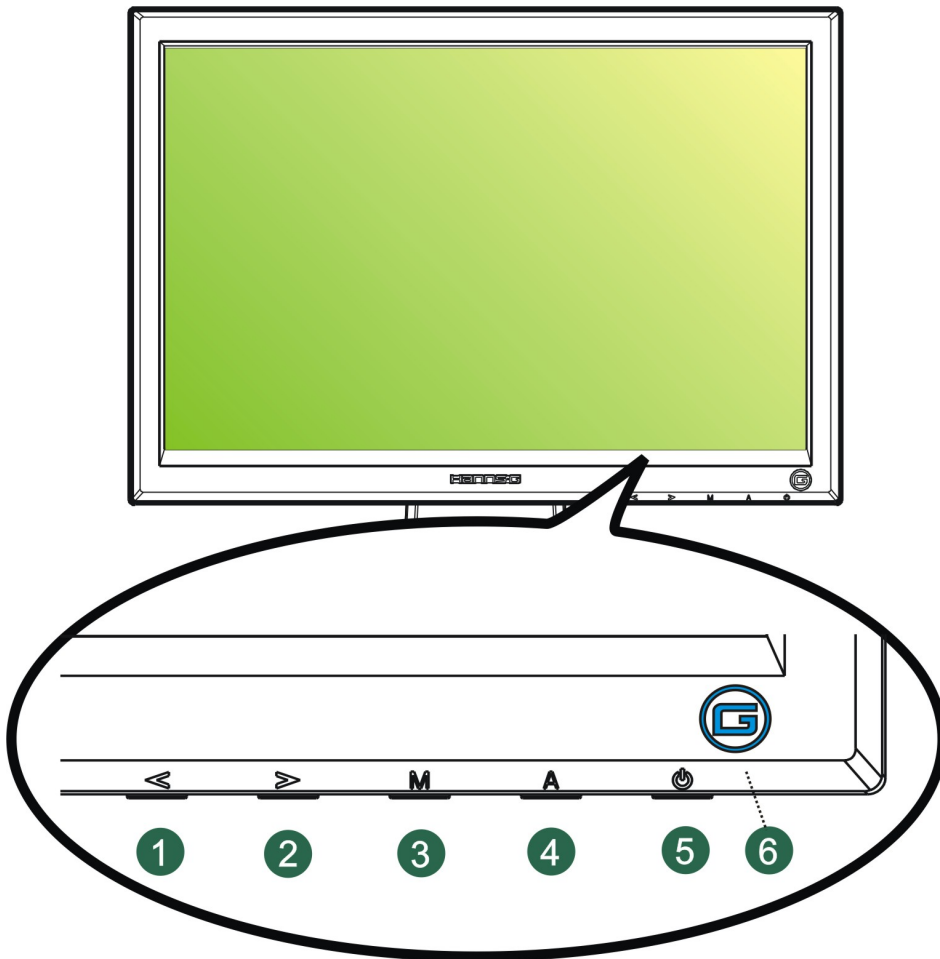

Figure.4. Control Panel Buttons

CONTROL PANEL BUTTONS:

1.	Volume <	2.	Volume >
3.	Menu / Enter	4.	Auto Adjustment
5.	Power Button	6.	Power Indicator

FRONT PANEL CONTROL

- **Power Button:**
Press this button to switch ON/OFF of monitor's power.
- **Power Indicator:**
Blue — Power On mode.
Orange — Power Saving mode.
- **MENU / ENTER:**
 1. Activate the OSD menu or adjust the function settings and confirmation or
 2. Exit OSD menu when in volume OSD status.
- **Adjust < >:**
 1. Activates the volume control when the OSD is OFF.
 2. Navigate through adjustment icons when OSD is ON or adjust a function when function is activated.
- **AUTO Button: (for D-sub only)**
When OSD menu is in off status, press and hold this button for more than two seconds to activate the Auto Adjustment function.
(The Auto Adjustment function is used to optimized the H-Position, V-Position, Clock and Phase.)

NOTES:

- Do not install the monitor in a location near heat sources such as radiators or air ducts, or in a place subject to direct sunlight, or excessive dust or mechanical vibration or shock.
- Save the original shipping box and packing materials, as they will come in handy if you ever have to ship your monitor.
- For maximum protection, repackage your monitor as it was originally packed at the factory.
- To keep the monitor looking new, periodically clean it with a soft cloth. Stubborn stains may be removed with a cloth lightly dampened with a mild detergent solution. Never use strong solvents such as thinner, benzene, or abrasive cleaners, since these will damage the cabinet. As a safety precaution, always unplug the monitor before cleaning it.
- **Function Key Lock:**
Press the 「<」, 「>」 and the 「**Menu**」 buttons simultaneously to enable the Function Key Lock. When the Function Key Lock is enabled, only the Power button is active. Press the 「<」, 「>」 and the 「**Menu**」 buttons simultaneously again to unlock the function keys.

HOW TO ADJUST A SETTING

Main Menu

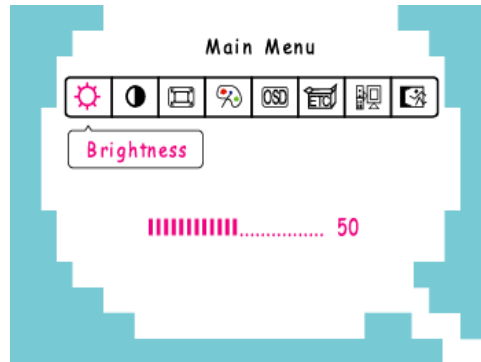

FUNCTION	DESCRIPTION
Brightness	Select the 「Brightness」 option on the 「Main Menu」. Enter the option by pressing the 「Menu」 button again, and adjust the level.
Contrast	Select the 「Contrast」 option on the 「Main Menu」. Enter the option by pressing the 「Menu」 button again, and adjust the level.
Image Setting	Select the 「Image Setting」 on the 「Main Menu」, and then enter the option.
Color Setting	Select the 「Color Setting」 option on the 「Main Menu」, and then enter the option.
OSD Setting	Select the 「OSD Setting」 option on the 「Main Menu」, and then enter the option.
Other Setting	Select the 「Other Setting」 option on the 「Main Menu」, and then enter the option.
Input Setting	Select the 「Input Setting」 option to change between the analog (D-Sub) or Digital (DVI) source. Enter the option and select Analog or Digital.
Exit	Exit the OSD menu function.

Image Setting

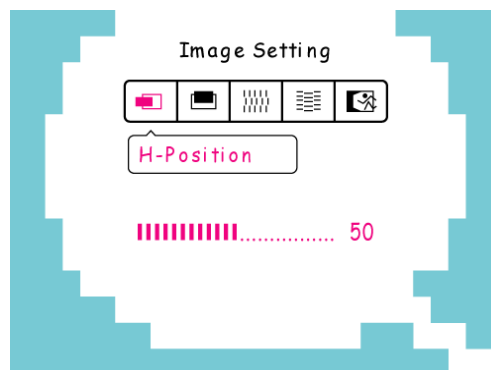

FUNCTION	DESCRIPTION
H-position	Select the 「H-position」 option to shift the screen image to the left or right. Enter the option and adjust the level.
V-position	Select the 「V-position」 option to shift the screen image up or down. Enter the option and adjust the level.

Clock Adjustment	Select the 「Clock Adjustment」 option to reduce the vertical flicker of characters on the screen. Enter the option and adjust the level.
Phase Adjustment	Select the 「Phase Adjustment」 option to reduce the horizontal flicker of characters on the screen. Enter the option and adjust the level.
Exit	Exit the OSD menu function.

Color Setting

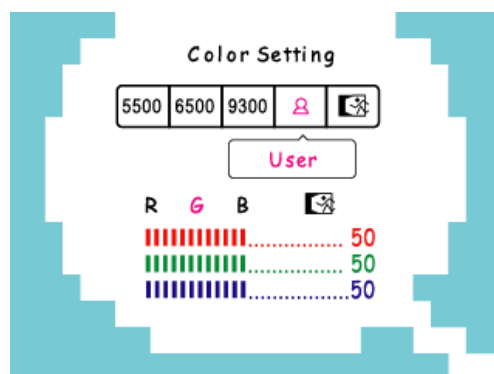

FUNCTION	DESCRIPTION
5500K/6500K/9300K	Move the cursor to one of the preset options and select it.
User	Move the cursor to the User option and select it 1. To adjust the red, enter the 「R」 option and adjust the level. 2. To adjust the green, enter the 「G」 option and adjust the level. 3. To adjust the blue, enter the 「B」 option and adjust the level.
Exit	Exit the OSD menu function.

OSD Setting

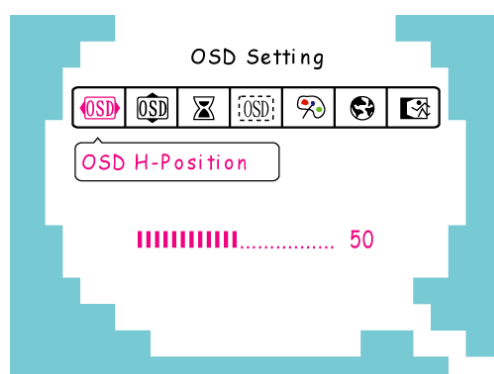

FUNCTION	DESCRIPTION
OSD H-Position	Select the 「OSD H-Position」 option to adjust the horizontal position of the OSD. Enter the option and adjust the level.
OSD V-position	Select the 「OSD V-Position」 option to adjust the vertical position of the OSD. Enter the option and adjust the level.
OSD Time-out	Select the 「OSD Time-out」 option to set the OSD time out from 10 to 120 seconds. Enter the option and adjust the level.
OSD Transparency	Select the 「OSD Transparency」 option to adjust the transparency of the OSD. Enter the option and adjust the level.

User's Manual

OSD Color	Select the 「 OSD Color 」 setting option to adjust the color of the OSD. Enter the option and adjust the level.
Language	Select the 「 Language 」 option to change the language of the OSD. Enter the option and select a language. (Reference only, the OSD Language is depended on selected model)
Exit	Exit the OSD menu function.

Other Setting

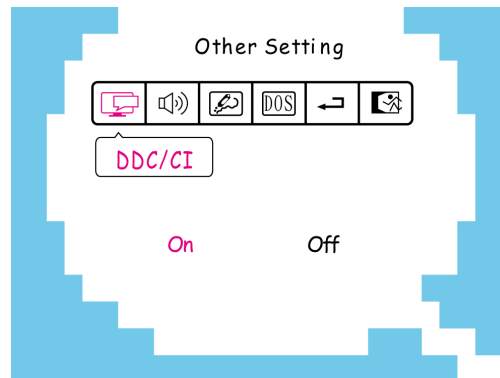

FUNCTION	DESCRIPTION
DDC/CI	Select the 「 DDC/CI 」 option to switch the function On or Off. (dual input mode optional)
Volume	Select the 「 Volume 」 option to change the volume level. Enter the option and adjust the level.
Sharpness	Select the 「 Sharpness 」 option to adjust the sharpness of the display. Set the value from 0 to 6.
DOS mode	Select the 「 DOS mode 」 option to set the monitor for use with PC. Enter the option and select 720 × 400 or 640 × 400.
Factory Preset	Select the 「 Factory Preset 」 option to reset to the monitor's default setting. This will erase the current settings. Enter the option and select On or Off.
Exit	Exit the OSD menu function.

PLUG AND PLAY

Plug & Play DDC2B Feature

This monitor is equipped with VESA DDC2B capabilities according to the VESA DDC STANDARD. It allows the monitor to inform the host system of its identity and, depending on the level of DDC used, communicate additional information about its display capabilities. The DDC2B is a bidirectional data channel based on the I²C protocol. The host can request EDID information over the DDC2B channel.

THIS MONITOR WILL APPEAR TO BE NON-FUNCTIONAL IF THERE IS NO VIDEO INPUT SIGNAL. IN ORDER FOR THIS MONITOR TO OPERATE PROPERLY, THERE MUST BE A VIDEO INPUT SIGNAL.

This monitor meets the Green monitor standards as set by the Video Electronics Standards Association (VESA) and/or the United States Environmental Protection Agency (EPA) and The Swedish Confederation Employees (NUTEK). This feature is designed to conserve electrical energy by reducing power consumption when there is no video-input signal present. When there is no video input signal this monitor, following a time-out period, will automatically switch to power saving mode. This reduces the monitor's internal power supply consumption. After the video input signal is restored, full power is restored and the display is automatically redrawn. The appearance is similar to a "Screen Saver" feature except the display is completely off. The display is restored by pressing a key on the keyboard, or clicking the mouse.

TECHNICAL SUPPORT (FAQ)

Q & A FOR GENERAL PROBLEMS

PROBLEM & QUESTION	POSSIBLE SOLUTION
Power LED is not on	*Check if the Power Switch is in the ON position *Power Cord should be connected
No Plug & Play	*Check if the PC system is Plug & Play compatible *Check if the Video Card is Plug & Play compatible *Check if any plug pins on the D-Sub or DVI-D connector are bent
The display is too dark or too bright.	*Adjust the Contrast and Brightness Controls.
Picture bounces or a wave pattern is present in the picture	*Move electrical devices that may cause electrical interference.
The power LED is ON (orange) but there's no video or no picture.	*Computer Power Switch should be in the ON position. *Computer Video Card should be snugly seated in its slot *Make sure monitor's video cable is properly connected to the computer. *Inspect monitor's video cable and make sure none of the pins are bent. *Make sure computer is operational by hitting the CAPS LOCK key on the keyboard while observing the CAPS LOCK LED. The LED should either turn ON or OFF after hitting the CAPS LOCK key.
Missing one of the primary colors (RED, GREEN, or BLUE)	*Inspect the monitor's video cable and make sure that none of the pins are bent.
Screen image is not centered or sized properly.	* Adjust pixel frequency CLOCK and PHASE or press hot-key (AUTO Button)
Picture has color defects (white does not look white)	* Adjust RGB color or select color temperature
The screen resolution needs to be adjusted	*Use win 2000/ME/XP Right click anywhere on desktop and select Properties>Settings>Screen Resolution . Use the slider to adjust the resolution and click Apply

ERROR MESSAGE & POSSIBLE SOLUTIONS

- **CABLE NOT CONNECTED :**
 1. Check that the signal-cable is properly connected, If the connector is loose, tighten the connector's screws.
 2. Check the signal-cable's connection pins for damage.
- **INPUT NOT SUPPORT :**
Your computer has been set to unsuitable display mode, set the computer to display mode given in the following table.

FACTORY PRESET TIMING TABLE:

MODE	RESOLUTION	HORIZONTAL FREQUENCY (KHz)	VERTICAL FREQUENCY (Hz)
1	640×350 @70Hz	31.469	70.087
2	640×400 @56Hz	24.827	56.424
3	640×400 @70Hz	31.469	70.090
4	640×480 @60Hz	31.469	59.940
5	640×480 @67Hz	35.000	66.667
6	640×480 @72Hz	37.861	72.809
7	640×480 @75Hz	37.500	75.000
8	720×400 @70Hz	31.469	70.087
9	800×600 @56Hz	35.156	56.250
10	800×600 @60Hz	37.879	60.317
11	800×600 @72Hz	48.077	72.188
12	800×600 @75Hz	46.875	75.000
13	832×624 @74.6Hz	49.725	74.500
14	1024×768 @60Hz	48.363	60.004
15	1024×768 @66Hz	53.964	66.132
16	1024×768 @70Hz	56.476	70.069
17	1024×768 @75Hz	60.023	75.029
18	1024×768 @75Hz	60.150	74.720
19	1152×864 @75Hz	67.500	75.000
20	1152×870 @75Hz	68.681	75.062
21	1152×900 @66Hz	61.846	66.004
22	1280×720 @60Hz	45.000	60.000
23	1280×768 @60Hz	47.776	59.870
24	1280×960 @60Hz	60.000	60.000
25	1280×1024 @60Hz	63.981	60.020
26	1280×1024 @75Hz	79.976	75.025
27	1360×768 @60Hz	47.712	60.015
28	1400×1050 @60Hz	64.744	59.948
29	1400×1050 @60Hz	65.317	59.978
30	1400×1050 @75Hz	82.278	74.867
31	1440×900 @60Hz	55.469	59.901
32	1440×900 @60Hz	55.935	59.887
33	1440×900 @75Hz	70.635	74.984

APPENDIX

SPECIFICATIONS

LCD Panel	Driving system	TFT Color LCD
	Size	17.0"
	Pixel pitch	0.255mm(H) x 0.255mm(V)
Video	H-Frequency	24KHz – 80KHz
	V-Frequency	55 – 75Hz
Display Colors		16.2M Colors
Max. Resolution		1440 x 900 @75Hz
Plug & Play		VESA DDC2B™
EPA ENERGY STAR®	ON Mode	≤36W
	Power Saving Mode	≤2W
	OFF Mode	≤1W
Audio output		Rated Power 1.2 W rms (Per channel)
Input Terminal		D-Sub DVI-D (Dual-Input Model)
Maximum Screen Size		Hor. : 367.2mm Ver. : 229.5mm
Power Source		100~240VAC,50±3Hz,60±3Hz
Environmental Considerations		Operating Temp: 0° to 50°C Storage Temp.: -20° to 60°C Operating Humidity: 10% to 80%
Dimensions		408 (W) x 368(H) x 220(D) mm 16.1 "(W)×14.5 "(H)×8.7 "(D)
Weight (NW)		3.3 kg (7.26 lb)

***The above specification is subject to actual product specification and is subject to change without prior notice.

NOTES:

The Maximum Resolution will depends on the display card supporting. Related issue can refer to www.hannsg.com FAQ section.